



# Operator Maintenance Manual

## 500 – 7000 lbs. AXLES

### IMPORTANT SAFETY NOTICE

Appropriate service methods and proper repair procedures are essential for the safe, reliable operation of all running gear as well as the personal safety of the individual doing the work. This manual provides general directions for performing service and repair work with tested, effective techniques. Following these guidelines will help assure reliability.

There are numerous variations in procedures, techniques, tools, and parts for servicing axles, as well as in the skill of the individual doing the repair. This manual cannot anticipate all such variations and provide advice or cautions as to each. Accordingly, anyone who departs from this manual must first establish that they neither compromise their personal safety nor the vehicle integrity by their choice of methods, tools, or parts.

### SET-UP AND ADJUSTMENT

For proper performance, all new axles should have the following checked at the specified intervals:

- WHEEL NUT TORQUE: at 10, 25, and 50 miles
- BRAKE ADJUSTMENT: at 200 and 3000 miles
- TIRE PRESSURE: to manufactures requirements

### HUBS/ DRUMS/ BEARINGS

Whenever the hub equipment on your axle must be removed for inspection or maintenance the following procedure should be followed.

1. Elevate and support the trailer unit per manufactures' instructions.
2. Remove the wheel assembly.
3. Remove the grease cap by carefully prying progressively around the flange of the cap.
4. Remove the cotter pin from the spindle nut or in the case of Safe-T-Lube, bend the tang washer to the free position.
5. Unscrew the spindle nut counter clockwise and remove the D-washer.
6. Remove the hub from the spindle, being careful to not let the outer bearing fall out.

Quality Driven...  
Customer Focused



# Operator Maintenance Manual

## BRAKE DRUM INSPECTION

There are two areas of the brake drum that are subject to wear and require periodic inspection. These two areas are the drum surface where the brake shoes make contact during stopping and the armature surface where the magnets contacts (only on electric brakes.) The drum surface should be inspected for excessive wear or heavy scoring. If worn more than .020" oversized, or the drum has worn out of round more than .015", then the drum surface should be turned. If scoring or other wear is greater than .090" on the diameter, the drum must be replaced. When turning the drum surface, the maximum re-bore diameter is as follows:

- 7" Brake Drum – 7.090"
- 10" Brake Drum – 10.090"
- 12" Brake Drum – 12.090"

The machined inner surface of the brake drum that contacts the Brake magnet is called the armature surface. If the armature surface is scored or worn unevenly, it should be refaced to a 120 micro inch finish by removing not more than .030" of material. To insure proper contact between the armature face and the surface should be refaced whenever the magnets are replaced.

**NOTE:** It's important to have wheel-bearing bores free of metallic chips and contamination. Make sure all cavities are free of contamination before reinstalling the bearing and seals.

## BEARING INSPECTION

Wash all grease and oil from the bearing cone using a suitable solvent. Dry the bearing with clean, lint free cloth and inspect the rollers completely. If any pitting, spalling, or corrosion is present, then replace the bearing. The bearing cup inside the hub must be inspected also. **ALWAYS REPLACE THE BEARINGS AND CUP IN SETS.**

When replacing the bearing cup proceed as follows:

1. Place the hub on a flat work surface with the cup to be replaced on the bottom side.
2. Using a brass drift punch, carefully tap around the small diameter end of the cup to drive it out.
3. After cleaning the hub bore area, replace the cup by tapping in with the brass drift punch. Be sure the cup is seated all the way up against the retaining shoulder in the hub.

Replace only with bearing as specified in the accompanying Bearing Replacement Chart.

## BEARING LUBRICATION

Along with bearing adjustment, proper lubrication is essential to the current function and reliability of your trailer axle. Bearing should be lubricated every 12 months or 12,000 miles. Repack bearings as follows:

1. Place a quantity of grease into the palm of your hand.
2. Press a section of the widest end of the bearing into the outer edge of the grease pile closet to the thumb forcing grease into the interior of the bearing.
3. Repeat this while rotating the bearing from roller to roller.
4. Continue this process until you have the entire bearing completely filled with grease.
5. Before installing, apply a light coat of grease on the bearing cup.

Quality Driven...  
Customer Focused



# Operator Maintenance Manual

## BEARING AND SEAL REPLACEMENT CHART

AXLE CAPACITY	SPINDLE DIAMETER	INNER BEARING/ CUP	OUTER BEARING/ CUP	SEAL NUMBER
2,000 lbs.	1"	44643/ 44610	44643/ 44610	12192TC
2,200 lbs.	1-1/16"	44649/ 44610	44649/ 44610	15192TC
3,500 lbs.	1-1/16" – 1-3/8"	68149/ 68111	44649/ 44610	171255TC
6,000 lbs.	1-1/4" – 1-3/4"	25580/ 25520	15123/ 15245	21333TC
7,000 lbs.	1-1/4" – 1-3/4"	25580/ 25520	14125/ 14276	21333TC

### SEAL INSPECTION AND REPLACEMENT

Whenever the hub is removed, it's recommended to replace the seals to assure that the seal properly seals the bearing cavity. To replace the seal:

1. Pry the seal out of the hub with a screwdriver. Never drive the seal out with the inner bearing as you may cause damage to the bearing.
2. Apply Permatex sealant to the outside of the new seal.
3. Tap the new seal into place using a clean wood block.

### BEARING ADJUSTMENT AND HUB REPLACEMENT

If the hub has been removed or bearing adjustment is required, the following adjustment procedure must be followed:

1. After placing the hub, bearing, washers, and spindle nut back on the axle spindle in reverse order as detailed in the previous section on hub removal, rotate the hub assembly slowly while tightening the spindle nut to approximately 50 lbs.-ft.
2. Then loosen the spindle nut to remove the torque. Do not rotate the hub.
3. Finger tighten the spindle nut until snug.
4. Back the spindle nut out slightly until the first castellation lines up with the cotter keyhole and insert the cotter pin (or locking tang in case of Safe-T-Lube.)
5. Bend over the cotter pin legs to secure the nut (or locking tang washer in case of Safe-T-Lube.)
6. Nut should be free to move with only restraint being the cotter pin (or locking Tab.)

### RECOMMENDED LITHIUM WHEEL BEARING GREASE:

Approved Sources:

- Mobil Oil – Mobil grease HP
- Exxon/ Standard – Renox MP
- Kendall Refining Co. – Kendall L-427
- Ashland Oil Co. – Valvoline Val-plex EP Grease

Quality Driven...  
Customer Focused



# Operator Maintenance Manual

## SAFE-T-LUBE

If your axle is equipped with Axis Safe-T-Lube Feature, the bearing can be periodically lubricated without removing the hub from the axle. This feature consists of axle spindles that have been specially drilled and fitted with a grease zerk in the ends. When grease is pumped into the zerk, it is channeled to the inner bearing then flows back to the outer bearing and eventually backs out the grease cap hole. The procedure is as follows:

1. Remove the rubber plug from the end of the grease cap.
2. Place a standard grease gun onto the grease zerk located in the end of the spindle. Make sure the grease gun is fully engaged on the fitting.
3. Pump grease into the zerk. The old, displaced grease will begin to flow back out of the cap around the grease gun nozzle.
4. When the new, clean grease is observed, remove the grease gun, wipe off any excess, and replace the rubber plug in the cap.

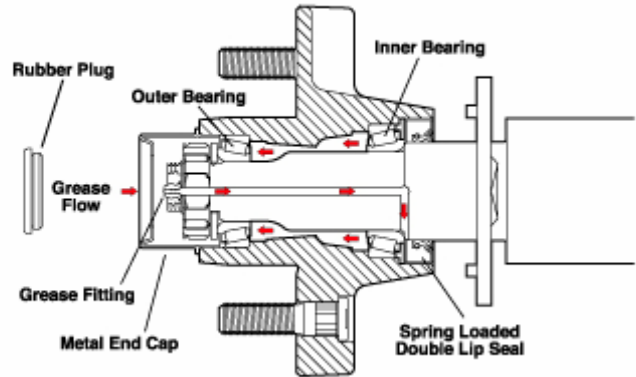

**Note:** The Safe-T-Lube feature is designed to allow immersion. Axles not equipped with Safe-T-Lube are not designed for immersion and bearings should be repacked after each immersion.

**Note:** Even with the Safe-T-Lube Feature, periodic inspection and repacking must be done every 12 months or 12,000 miles. Do not pack hub full of grease. Excessive grease may leak into brake drums causing brake failures.

## SUSPENSION TYPES

The suspension systems incorporated into Axis axles are designed to provide the trailer owner three basic functions:

1. Attach the axle to the trailer.
2. Dampen the effects of road shock.
3. Provide stability to the trailer.

All Axis suspension systems are available in single and multiple axle configurations. These are discussed in the following:

## DOUBLE EYE LEAF SPRINGS

Double eye springs have eyes formed in each end of the spring and are attached to the trailer as follows:

1. The front spring eye is attached directly to the front hanger with a bolt and nut.
2. The rear spring eye is attached to a pair of shackle links, which are attached

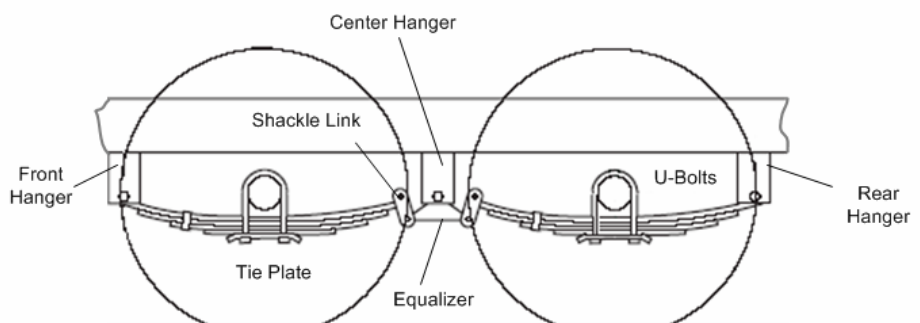

Quality Driven...  
Customer Focused



# Operator Maintenance Manual

to either a rear The articulation of this suspension occurs when the spring becomes loaded and consequently lengthens. The double pivot action of the shackle links accommodates this articulation and allows the system to move freely. In multiple axle installations the action is the same, but with the additional movement of the equalizer assembly that serves to transfer instantaneous loads from one axle to another, in effort to “equalize” the load between the axles.

## SLIPPER SPRINGS

Slipper springs have an eye formed in one end only with the other end formed into a reverse curve. The attachment of these springs is as follows:

1. The front eye is attached directly into the front hanger with a nut and a bolt.
2. The rear end of the spring is captured in the rear hanger or equalizer with a “keeper bolt” that prevents the spring from coming out when the trailer is jacked up for service.

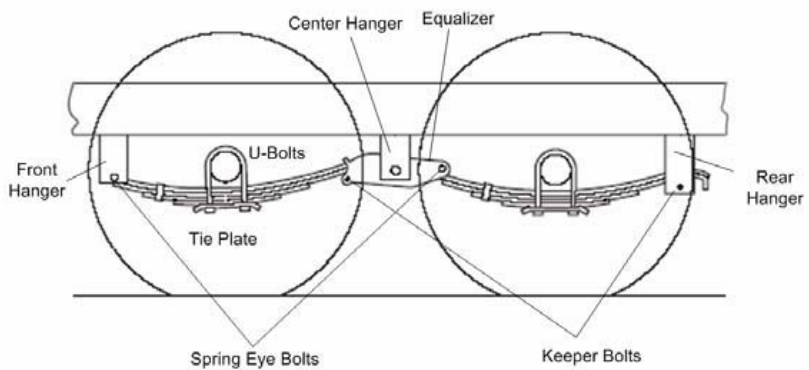

The articulation of this suspension occurs when the rear end of each slipper spring slides against the wear surfaces provided in the rear hangers or equalizers. This suspension is also available in single and multiple axle configurations.

## RUBBER TORSION SUSPENSION

The RUBBER TORSION suspension system is a torsion arm type suspension, which is completely self-contained within the axle tube. It attaches directly to the trailer frame using brackets, which are an integral part of the axle assembly. The RUBBER TORSION axle provides improved suspension characteristics relative to leaf spring axles through the unique arrangement of a steel torsion bar surrounded by four natural rubber cords incased in the main structural member of the axle beam. The wheel/hub spindle is attached to a lever, called the torsion arm, which is fastened to the rubber-encased bar. As the load applied, the bar rotates causing a rolling/ compressive resistance in the rubber cords. This action provides the same functions as conventional sprung axles with operating advantages including independent suspension.

## INSPECTION AND REPLACEMENT

All the components of your suspension system should be visually inspected at least every 6,000 miles for signs of excess ware, elongation of bolt holes, and loosening of fasteners. Whenever loose or replaced, the fasteners in your suspension system should be torqued as in the chart below.

Item	Torque (lbs. / ft.)	
	Min.	Max.
½" U-Bolt	45	60
Shackle Bolt	Snug fit only. Parts must rotate freely. Locking nuts or cotter pins are provided to retain nut-bolt assembly.	
Spring Eye Bolt		
Equalizer		
Shoulder Type	30	50
Shackle Bolt		

**Quality Driven...  
Customer Focused**



# Operator Maintenance Manual

Worn spring eye bushings, sagging springs, or broken springs should be replaced using the following method.

1. Support the trailer with the wheels just off the ground. *Follow the trailer manufacturer's recommendations for lifting and supporting unit.* Do not lift or place supports on any part of the suspension system.
2. After the unit is properly supported place a suitable block under the axle tube near the end to be repaired. This block is to support the weight of the axle only so that suspension COMPONENTS can be removed.
3. Disassemble the U-bolts, nuts, and tie plates.
4. Remove the spring eye bolts and remove the spring and place on a suitable work surface.
5. If the spring eye bushings are to be replaced, drive out the old bushing using a suitable drift punch.
6. Drive the new bushing into the spring eye using a piloted drift punch or a close fitting bolt inserted through the bushing.
7. Reinstall replaced components in reverse order. **NOTE:** For multiple axle units, the weight of each axle must be supported as outlined in step 2 before disassembly of any component of the suspension system.

If the equalizer or equalizer bushing must be replaced, follow the instructions above for lifting and supporting the trailer unit and then proceed as follows:

1. With both axles blocked up, remove the spring eye bolt, shackle bolt, and equalizer bolt from the equalizer to be repaired or replaced.
2. Take the equalizer to a suitable work surface and remove the worn bushings using a drift punch.
3. Drive the new bushing into place using a piloted drift punch or a close fitting bolt through the bushing.
4. Reassemble in reverse order.

All of the pivot points on your suspension system have been fitted with anti friction bearing materials which do not require routine lubrication. However, when otherwise servicing the unit, these pivot points may be lubricated if you so desire. Except for periodic inspection of the fasteners used to attach the RUBBER TORSION axle to the vehicle frame, no other suspension maintenance is required on RUBBER TORSION axles. They are, of course subject to the maintenance and inspection procedures regarding brakes, hubs, bearings, wheels, and tires as outlined in this manual.

## WHEEL AND TIRES

### TORQUE REQUIREMENTS

It is extremely important to apply and maintain proper wheel mounting torque on your trailer axle. Torque is a measure of the amount of tightening applied to a fastener (nut or bolt) and is expressed as length times force. For example, a force of 90 pounds applied at the end of a wrench one foot long will yield 90 lbs. – ft. of torque. Torque wrenches are the best method to assure the proper amount of torque is being applied to a fastener.

**NOTE:** Wheel nut or bolts must be applied and maintained at the proper torque levels to prevent loose wheels, broken studs, and possible dangerous separation of wheels from your axle.

Be sure to use only fasteners matched to the cone angle of your wheel (usually 60 or 90 degrees.) The proper procedure for attaching your wheels is as follows:

1. Start all bolts or nuts by hand to prevent cross threading.
2. Tighten bolts or nuts in the following sequence.

Quality Driven...  
Customer Focused



# Operator Maintenance Manual

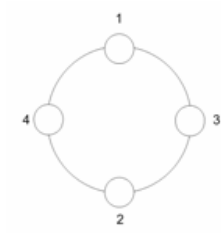

4 BOLT

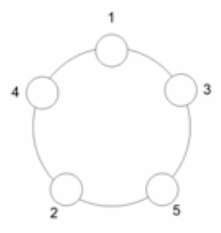

5 BOLT

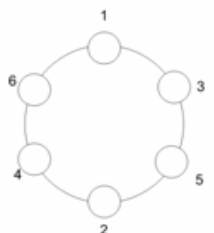

6 BOLT

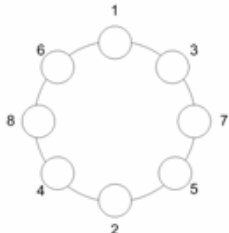

8 BOLT

- The tightening of the fasteners should be done in stages. Following the recommended sequence, tighten fasteners per the wheel torque chart.
- Wheel nuts/ bolts should be torqued before the first road use and after each wheel removal. Check and re-torque after the first 10 miles, 25 miles, and again at 50 miles. Check periodically thereafter.

**CAUTION:** Incorrect wheel nuts or improperly tightened wheel nuts can cause the wheel to become loose and even come off. Be sure to use the correct wheel nuts.

## WHEEL TORQUE REQUIREMENTS

Wheel Size	1 <sup>st</sup> Stage	Torque Sequence 2 <sup>nd</sup> Stage	3 <sup>rd</sup> Stage
12"	20-25	35-40	50-75
13"	20-25	25-40	50-75
14"	20-25	50-60	90-120
15"	20-25	50-60	90-120
16"	20-25	50-60	90-120

## TIRE WEAR DIAGNOSTIC CHART

Tire Wear Diagnostic Chart

Wear Pattern	Cause	Action
Center Wear	Over Inflation	Adjust pressure to particular load per tire catalog
Edge Wear	Under Inflation	Adjust pressure to particular load per tire catalog
Side Wear	Loss of camber or overloading	Make sure load doesn't exceed axle rating. Align at alignment shop.
Toe Wear	Incorrect toe-in	Align at alignment shop.
Cupping	Out-of-balance	Check bearing adjustment and balance tires.
Flat Spots	Wheel lockup & tire skidding	Avoid sudden stops when possible and adjust brakes.

Quality Driven...  
Customer Focused



# Operator Maintenance Manual

## STORAGE PREPARATION

1. Jack up the trailer and place jack stands under the trailer frame so that the weight will be off the tires. Follow trailer manufacturer's guidelines to lift and support the unit. Never jack up or place jack stands on the axle tube or on the equalizers.
2. Lubricate mechanical parts such as the hitch, and the suspension parts, that are exposed to the weather.
3. Boat trailer axles are subject to repeated immersion. Before storing, remove brake drums; inspect bearings – clean and lubricate.

## PROLONG STORAGE INSPECTION PROCEDURES

Before removing trailer from jack stands:

1. Remove all wheels and hubs or brake drums. Note which spindle and brake that the drum was removed from so that it can be reinstalled in the same location.
2. Inspect suspension for wear.
3. Check tightness of the hanger bolts, shackle bolt, and U-bolt nuts per recommended torque values.
4. Check brake linings, brake drums and armature faces for excessive wear or scoring.
5. Lubricate all brake moving parts.
6. Remove any rust from surface of drums with fine emery paper.
7. Inspect grease seals for wear or nicks. Replace if necessary.
8. Lubricate hub bearings.
9. Reinstall hubs and adjust bearings per instructions in this manual.
10. Mount and tighten wheels nuts per instructions in manual.

## MAINTENANCE SCHEDULE

Weekly – Check tire pressure

3000 miles or 3 months – Brake adjustment, Torque on wheel nuts, and Tire inspection for wear.

6000 miles or 6 months – Inspect brake magnets for wear, Inspect suspension parts for wear.

12,000 miles or 12 months – Inspect brake lining wear, brake cylinder leaks, brake lines, Grease bearings, Check hub for wear, Inspect grease seal, and Inspect springs for any wear or loss of arch.

Quality Driven...  
Customer Focused

